

Gjødselutstyr



Vi er leverandør til de fleste norske produsenter og importører av gjødselvogner og gjødselutstyr.

Vi leverer pumper, ventiler, nav og trekkøyer mm. Vi har et omfattende delelager som sikrer raske leveringer. Vi har også pumper for mer industrielt bruk, seriene BR, WPT og KTM.



Prinsippskisse gjødselvogn

Gjødselutstyr

MEC

Vakumpumpe med dryppsmøring og sikkerhetsventil



Battioni®
Pagani
Pompe



OLJER :
Gearboks : ISO VG 460.
Dryppsmøring: ISO VG 100.
Til dryppsmøringen kan vår egen vakumpumpeolje benyttes :
BP5070200100 5 ltr. 1.637,-



Battioni's MEC kompressorer er brukt i mange år bla til å tømme gjødseltanker og transportere gjødsel. Pumpene kan også benyttes til gjødsling og vanning. De har en utmerket pålitelighet og utrolig lang levetid.

Våre standardpumper er utstyrt med "tvungen" dryppsmøring, de kan også monteres med automatisk smøring.

Pumpene kan også leveres med hydraulisk drift, elektrisk drift eller med kilerems drift.

Klargjort for montering av sikkerhetsventil.



Hydr.styring for MEC 5000-8000 :
BP6080200175 Kr. 3.429,-

MEC 9000—11000—13500 :

Dette er en helt ny pumpefamilie fra Battioni. Pumpene har et sikkerhetssystem som beskytter huset og rotoren hvis en av lamellene skulle knekke, dette er mulig pga. avlange monteringshull for flensen til gearboksen. Større ribber utvendig på huset, for bedre å fjerne varme. Varmeindikator er montert på huset. Spesial lameller, for lang levetid. Inspeksjons hull for lameller med indikator for slitasje. Stor slitestyrke på hus, pga. støpegods med hard herding. Klargjort for montering av sikkerhetsventil. Pumpene kan også levers med luft kjøle system kalt BALLAST.

Versjon MA har max.1000.omdr/min.

Type	Max kap. Ltr./min.	Arb. Omdr/min.	Max Omdr/min	Max Trykk. Bar	Max Vakuum. Bar	Vekt Kg.	Varenr.	Pris
MEC 1000/P For kilereim, Ø22	1260			1,5	0,94	34	BP9010000024	21.659,-
MEC 1000/H m/tannhjulsmotor	1260			1,5	0,94	48	BP9360000006	28.816,-
MEC 4000/M	4350	600	1400	1,5	0,94	100	BP9000400001	27.508,-
MEC 5000/M	6150	600	1400	1,5	0,94	130	BP9000500001	29.427,-
MEC 6500/M	7000	600	1400	1,5	0,94	148	BP9000600001	29.450,-
MEC 8000/M	8000	600	1400	1,5	0,94	160	BP9000700001	34.617,-
MEC 9000/M	9030	600	540	1,5	0,95	145	BP9000900001	38.633,-
MEC 11000/M	11137	600	540	1,5	0,95	160	BP9001100001	44.285,-
MEC 13500/M	13845	600	540	1,5	0,95	178	BP9001350001	50.820,-
Sikkerhetsventil MEC 4000			1 1/4"				BP5100200009	1.420,-
Sikkerhetsventil MEC 5000		- 8000	1 1/2"				BP5100200010	1.431,-
Sikkerhetsventil MEC 9000		- 13500	2"				RIV2502	1.484,-

Gjødselutstyr

MEC INFORMASJON

MEC 1000 - 1600 - 2000 - 3000 - 4000 - 5000 - 6500



Battioni®
Pagani
Pompe

Hendel for valg : Vakum - trykk.

Klargjort for sikkerhetsventil

Tilbakeslagsventil er standard

Inspeksjonshull for lameller.

Tvungen dryppsmøring er standard.
Automatisk dryppsmøring etter forespørsel.

Long-life lameller etter forespørsel.

Høy slitestyrke takket være støpejern
med høy hardhet

VERSJONER :



MEC M
PTO drift. 1 3/8" Z6. (Max. 600rpm)



MEC P
Kilereimsdrift. Glatt sylindrisk akse Ø22,
lengde 48mm. Kile UNI 6604. (Max. 1400rpm)

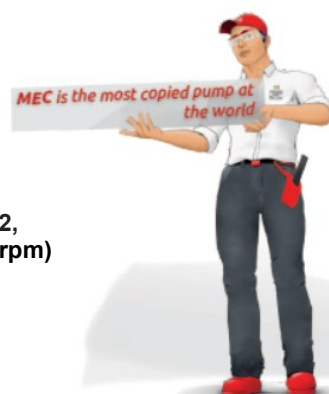

MEC D
Direkte drift. 1 3/8" Z6. (Max. 1400rpm)



MEC H
Hydraulisk drift. (Max. 1400rpm)

Gjødselutstyr

MEC INFORMASJON

MEC 1000 - 1600 Lett og kompakt design.



Battioni®
Pagani
Pompe

Påliteligheten og styrken til MEC er resultatet av kontinuerlig design og produktforbedringer gjennom 40 år. Det lette og kompakte designet gjør MEC 1000/1600 til den beste vakumpumpen for bærbare **sanitærtjenester** og små **vakumtanker** for væskeformål.

Funksjoner :

- 4-veis ventil, tilbakeslagsventil
- Tilgjengelige slangetilkoblinger: Ø 27mm / Ø 45mm / G 1"
- NB : Ikke utstyrt med gjenger for sikkerhetsventil.

Valgmuligheter :



Long-life lameller



Automatisk smøring



Tilpasset farge.
NB : Minimumsantall

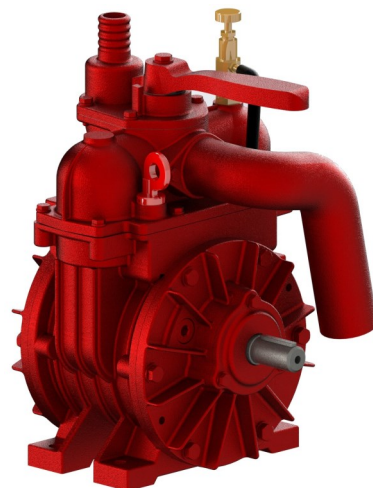

MEC 2000 - 3000 - 4000 Lett og kompakt design.

Funksjoner :

- 4-veis ventil, tilbakeslagsventil, tvungen smøring.
- Tilgjengelige slangetilkoblinger: Ø 45mm / Ø 60mm / Ø 2"
- Utstyrt med gjenget hull for sikkerhetsventil. G 1 1/4".

VERSJONER :



MEC M

PTO drift. 1 3/8" Z6. (Max. 600rpm)
Dreieretning : Mot klokken.



MEC D

Direkte drift. 1 3/8" Z6. (Max. 1400rpm)
Dreieretning : Mot klokken.



MEC P

Kilereimsdrift. Glatt sylindrisk aksele Ø30, lengde 70mm. Kile UNI 6604. (Max. 1400rpm)
Dreieretning : Med klokken (standard), mot klokken (opsjon).

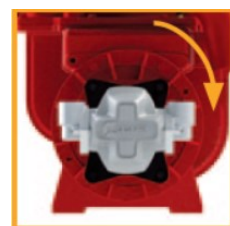

MEC H

Hydraulisk drift. (Max. 1400rpm)
Dreieretning : Med klokken.
MEC 2000: Gr. 3 26.7 cc/rev - Pmax 280 bar - Inn G 1" - Ut G 3/4"
MEC 3000: Gr. 3 26.7 cc/rev - Pmax 280 bar - Inn G 1" - Ut G 3/4"
MEC 4000: Gr. 3.5 43.98 cc/rev - Pmax 250 bar - Inn G 1" - Ut G 1"
Dreieretning : Med klokken.

Gjødselutstyr

MEC 5000 - 6500 - 8000 Legendene.

Over hele verden har mer enn 500.000 MEC pumper har blitt satt i drift for å tømme septikk og transportere gjødsel (og mange andre væsker) innenfor mange forskjellige sektorer. Stor slitestyrke og lang levetid er kjennetegn som passer godt for MEC pumpene.



Battioni®
Pagani
Pompe

Funksjoner :

- 4-veis ventil, tilbakeslagsventil, tvungen smørning.
- Tilgjengelige slangetilkoblinger: Ø 60mm / Ø 76mm (3") / Ø 80
- Utstyrt med gjenget hull for sikkerhetsventil. G 1 1/4".

VERSJONER :



MEC M

PTO drift. 1 3/8" Z6. (Max. 600rpm)
Dreieretning : Mot klokken.



MEC D

Direkte drift. 1 3/8" Z6. (Max. 1400rpm)

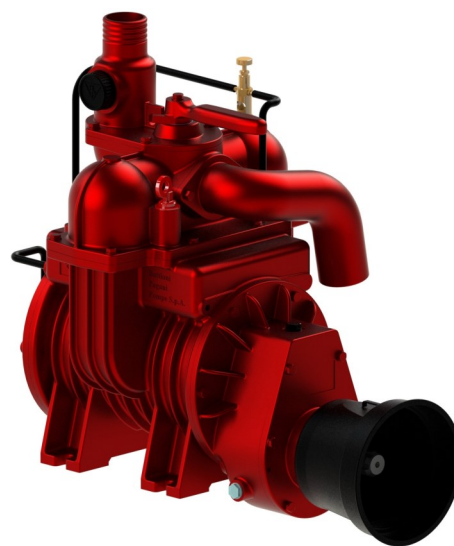

MEC P

Kilereimsdrift. Glatt sylindrisk akse Ø32, lengde 70mm. Kile UNI 6604. (Max. 1400rpm)
Dreieretning : Med klokken (standard), mot klokken (opsjon).

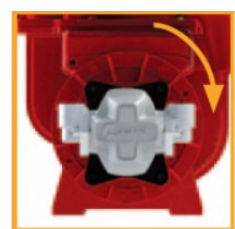

MEC H

Hydraulisk drift. (Max. 1400rpm)

Dreieretning : Med klokken.

MEC 5000: Gr. 3,5 43,98 cc/rev - Pmax 250 bar - Inn G 1" - Ut G 1"

MEC 6500: Gr. 3 43,98 cc/rev - Pmax 250 bar - Inn G 1" - Ut G 1"

MEC 8000: Gr. 3,5 51,83 cc/rev - Pmax 230 bar - Inn G 1" - Ut G 1"

Dreieretning : Med klokken.

Valgmuligheter :



Long-life lameller



Automatisk smørning
MEC 5000 :
Enkelt smørningspunkt.
MEC 6500/8000 :
Dobbelt smørningspunkt



Sideuttak med tvribare albuer.



Dobbelt uttak Ø 60mm



Vribare albuer
Ø 60mm
Ø 76mm (3")
Ø 80mm



EN 707 vendehåndtak
Best.nr. : BP6080200161



Hydraulisk vender
Best.nr. : BP6080200175



Hydraulisk roterende vender
Best.nr. : BP509000073



Pneumatisk roterende vender
Best.nr. : BP6080200114



Tilpasset farge.
NB : Minimumsantall

Gjødselutstyr

GARDA MEC Kombinert vakum- og sentrifugalpumpe med automatisk smøring



Garda pumpen kombinerer det beste av vakum (MEC/WPT/STAR) og sentrifugalpumpe (ELBA). Vakumpumpen til å fylle tanken og sentrifugalenheten til å spre gjødselen ut under høyt trykk. Man velger funksjon ved hjelp av et håndtak på gearboksen. Det manuelle håndtaket kan evt. også opereres hydraulisk.

Type	Max kap. Ltr./min.	Arb. Omdr/ min.	Max Omdr/ min	Max Trykk. Bar	Max Vakuum. Bar	Vekt Kg.	Varenr.	Pris
Garda/Mec 6500	6500	540	540	7,0	-0,94	280	BP9300000000	96.761,-
Garda/Mec 8000	8000	540	540	7,0	-0,95	297	BP9300000001	100.399,-
Garda/Star 72	12 000	540	540	7,0	-0,95	427	BP9300000002	115.866,-
Sikkerhetsventil	Garda/Mec	1 1/2"					BP5100200010	1.431,-
Sikkerhetsventil	Garda/Star	2"					RIV2502	1.484,-

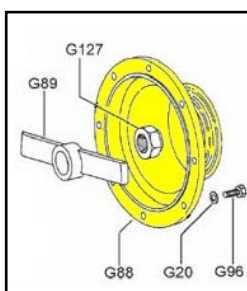

Garda og Elba kan leveres med et ekstra kutte organ. Dette kutter opp det inngående materialet i ytterligere småbiter før det går gjennom pumpen.

Best. Nr : **BP6080200009**

Pris : **Kr. 13.703,-**



Hydraulisk styring for Garda :

Best. Nr : **BP5090000011**

Pris : **Kr. 10.218,-**



Gummimansjett Ø200 med 2 slangeklemmer

Best. Nr : **BP5060010002**

Pris : **Kr. 1.637,-**

Gjødselutstyr

ELBA Sentrifugalpumpe / Høytrykkpumpe



Battioni®
Pagani
Pompe



Vår standard Elba pumpe består av en gearboks med utveksling 1:3 og en sentrifugalpumpe.

For eldre traktorer med kun 540 omdr. tapp kan vi også levere pumpen med utveksling 1:4.

Brukt til å håndtere flytende gjødsel og flytende stoffer generelt. Mye brukt til gjødselspredning.

Pumpen har et kraftbehov på 70 hk for å gi maksimal ytelse.

Type	Max kap. Ltr./min.	Max Omdr/min	Max Trykk. Bar	Max trykkhøyde	Vekt Kg.	Varenr.	Pris
Elba 6500 1:3	6500	750	7,0	70 mtr.	90	BP9220605136	40.438,-
Elba 6500 1:4	6500	540	7,0	70 mtr.	90	BP9220605108	40.438,-
Kutteorgan til ELBA	Se s. 3/14					BP6080200009	12.235,-

BR Dreiestempelpumpe



Dreiestempelpumpe med gummierte lameller.
Kan kjøres begge veier.
Godt egnet for både landbruk og industri. Opp til 10 bars trykk. Pumpen er selvstugende.

Type	Max kap. Ltr./min.	Max Omdr/min	Max Trykk. Bar	Kraft Behov kW / HK	Vekt Kg.	Varenr.	Pris
BR 40/D	710	540	10	13 / 17,4	103	BP9401500000	61.459,-
BR 80/D	1425	540	10	27 / 36,2	121	BP9401600000	66.930,-
BR 120/D	2125	540	10	39 / 52,2	139	BP9401700000	78.183,-
BR 160/D	2875	540	8	43 / 57,6	163	BP9401800000	91.068,-
BR 200/D	3500	540	7	48 / 64,3	182	BP9401900000	97.768,-
BR 240/D	4250	540	6	50 / 67,0	198	BPBR240D	*
BR 280/D	4950	540	5	52 / 69,7	218	BP9402100000	*

Gjødselutstyr

KPS

Vakumpumpe med automatisk smøring, std. vannkjølesystem.



Battioni®
Pagani
Pompe



KPS-serien med pumper har væskekjølt hus som gjør det mulig med kontinuerlig drift både i vakuu- og trykkmiljøer.

KPS-serien er beregnet for bruksområder der det kreves langvarig, kontinuerlig og uavbrutt drift (for eksempel i oljefelt, kombinerte vakuumbiler og industrielle bruksområder).

KPS-serien er det ideelle valget for profesjonelle brukere og entreprenører.

STANDARDFUNKSJONER

Automatisk smøring (2, 3 eller 4 punkter), kjølepumpe, 4-veis ventil, Poppet sjekkventil, Sideuttak med roterende albuer, Kniver med lang levetid, Kollisjonsbeskyttelsessystem, Luftinjeksjonskjøling, Forberedt for integrert luftfilter. Tilgjengelige slangekoblinger: Ø 76 mm (3 tommer) / Ø 80 mm / Ø 100 mm (4 tommer).

Type	Max kap. Ltr./min.	Arb. Omdr/min.	Max Omdr/min	Effekt behov. Hk	Max Vakuum. Bar	Vekt Kg. Type MA	Varenr.	Pris
KPS 490	13.520	600	1000	19	0,95	221		
KPS 550	15.270	600	1000	22	0,95	236		
KPS 670	18.620	600	1000	25	0,95	265		

Spør oss om tilbud.

Gjødselutstyr

KTM Vakumpumpe med vannkjøling



KTM-serien er en forholdsvis ny pumpeserie, produsert med tekniske finesser og med materialer av høy kvalitet. Denne serien består av fire modeller (KTM 1200, KTM 1500, KTM 1800 og KTM 2300) med kapasiteter fra 21 500 lt / min. til 36 300 lt / min. og den er tilgjengelig i versjonene HFR (hydraulisk drift/stempelmotor) og PFR (direkte drift).

Kompressoren er utstyrt med et automatisk smøresystem og, på forespørsel, med et vann-kjølesystem på pumpehus og flenser. Pumpen tåler kontinuerlig drift. Det er også tilgjengelig mye forskjellig ekstrautstyr.



Type	Max kap. Ltr./min.	Max Omdr/ min	Max Trykk. Bar	Max Va- kuum. Bar	Effekt Behov kW	Vekt Kg.	Varenr.	Pris
KTM 1200	21.500	1.400	1,5	0,95	57	391	BPKTM1200	*
KTM 1500	26.400	1.400	1,5	0,95	70	446	BPKTM1500	*
KTM 1800	31.000	1.400	1,5	0,95	75	610	BPKTM1800	*
KTM 2300	36.300	1.400	1,5	0,95	84	673	BPKTM2300	*

Gjødselutstyr— Deler



Battioni®
Pagani
Pompe

LAMELLER



Se våre kundesider på nett for komplette split-tegninger og delelister.

For pumpe	Lengde Mm.	Bredde Mm.	Tykkelse Mm.	Antall	Varenr.	Pris
MEC 1000	120	38	6,3	5	BP4070113001	*
MEC 1600	190	38	6,3	5	BP4070113002	188,-
MEC 2000	180	41	6,3	7	BP4070113003	*
MEC 3000	240	41	6,3	7	BP4070113004	*
MEC 4000	300	41	6,3	7	BP4070113005	188,-
MEC 5000	300	46,5	6,3	7	BP4070113006	224,-
MEC 6500	370	46,5	6,3	7	BP4070113007	265,-
MEC 8000	450	46,5	6,3	7	BP4070113008	318,-
WPT 480 LL	300	73,5	7,5	6	BP4070113160	1.368,-
WPT 600 LL	400	73,5	7,5	6	BP4070113161	1.548,-
WPT 720 LL	500	73,5	7,5	6	BP4070113162	2.246,-
AGRI 60 LL	350	70	4,7	6	BP4070113163	*
AGRI 72 LL	400	70	4,7	6	BP4070113101	1.973,-
AGRI 84 LL	480	70	4,7	6	BP4070113165	*
SE 10000 Gml	350	70	9,5	6	BP4070113027	719,-
STAR 72	400	70	7,5	6	BP4070113028	502,-

LAMELL KIT



LL = Long Life lameller

Kittene inneholder alt man trenger av lameller, o-ringer, pakninger og simmeringer for en fullstendig overhaling.

Se ellers våre nettsider for en komplett oversikt/deleliste.

For pumpe	Varenr.	Pris
MEC 1000	BP6010201001	638,-
MEC 4000	BP6010201005	1.755,-
MEC 5000	BP6010201006	2.185,-
MEC 6500	BP6010201007	2.548,-
MEC 8000	BP6010201008	2.864,-
STAR 60	BP6010201011	*
STAR 72	BP6010201012	*
AGRI 60 LL	BP6010201027	*
AGRI 72 LL	BP6010201028	*
WPT 480 PR	BP6010201030	8.473,-
WPT 480 PFR	BP6010201033	9.822,-
WPT 720 PR	BP6010201032	13.005,-
WPT 720 PFR	BP6010201035	13.611,-

Eksempel på innhold i Kit— MEC 4000

BP4030108004 M04 pakning	2 stk.
BP4030108005 AM13 pakning	2 stk.
BP4030108006 AM28/M28 pakning	1 stk.
BP4030108011 LA04 Pakning oljepumpe	1 stk.
BP4030108029 M103/AM101 Pakning Garda/Mec	1 stk.
BP4030109003 M39 Pakning manifold	1 stk.
BP4030109004 M42 Pakning manifold	1 stk.
BP4030110002 M37 pakning	1 stk.
BP4070113005 Lamell 300x41x6,5 MEC4000. MEC7.	7 stk.
BP5030210028 LF22 O-ring, oljepumpe	1 stk.
BP5030210038 M110 O-ring front cover	1 stk.
BP5030300002 Simmerring 35x52x10 M53 MEC/D	1 stk.
BP5030300003 Simmerring 25x35x7 M40	1 stk.
BP5030300004 Simmerring 40x52x7 M18	4 stk.
BP5030300005 Simmerring 35x62x10 AM27/G25	1 stk.
BP5030300013 Simmerring 55x68x8 M80 MEC/H	1 stk.
BP5030300032 Simmerring 45x60x10 M76 MEC/D	1 stk.

**Pakning og simmering kit.
Inneholder alle pakninger og simmeringer**

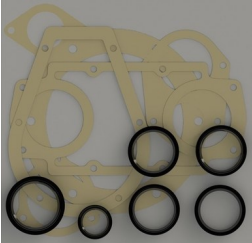
	Beskrivelse	Varenr.	Pris
	For MEC 1000-1600 For MEC 2000-3000-4000 For MEC 5000-6500-8000 For Mec 9000-11000-13500 For STAR For WPT	BP6010202001 BP6010202002 BP6010202003 BP6010202004 BP6010202008 BP6010202009	638,- 713,- 769,- 968,- 904,- 1.440,-

ELBA / IDRA - mest brukte deler

	Beskrivelse	Varenr.	Pris
	EL16/I93/G98 mekanisk tetning Elba 6500 Brukt på pumper fom. 2000.	BP5030000003	8.605,-
	G47/I63 pakning 50x70x10 Grafitti pakningene ble erstattet av den mekaniske tetningen i år 2000. Antall pr. pumpe : 6 stk.	BP4030111001	153,-
	G52 pumpeskovel (I66-EL21)	BP4011219001	2.745,-
	G59(I69) EL 32 flens bak m/slangestuss for gummimansjett.	BP4010401010	2.766,-
	Gummimansjett Ø200 med 2 stk. slangeklemmer. Gummimansjett Ø150 med 2 stk. slangeklemmer.	BP5060010002 BP5060010004	1.637,- 1.247,-

Gjødselutstyr



Battioni®
Pagani
Pompe

Filler

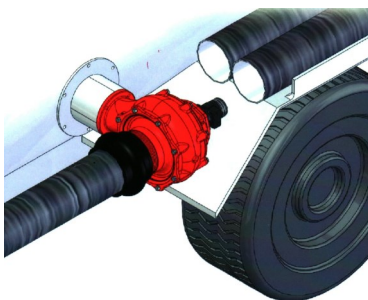

Filler er en sentrifugalpumpe i støpejern med et skovlehjul drevet av en hydraulisk motor.

Fordeler :

Man kan fylle tanken fullstendig.

Øker fyllhastigheten, forlenger levetiden på vakumpumpen og forlenger serviceintervallene.

Fremmedlegemer kan kuttes ved hjelp av kutteorganet (monteres på i tillegg, se side 3/15)

Skumproblemer unngås.

Best.nr. Filler :

BP6080200157

Pris : 33.793,-

Best.nr. Filler m/kutteorgan

BP6080200158

Pris : 41.209,-

Best.nr. Hydraulikkmotor

MEOP100C

Pris : 3.666,-

Svivler— Mekaniske

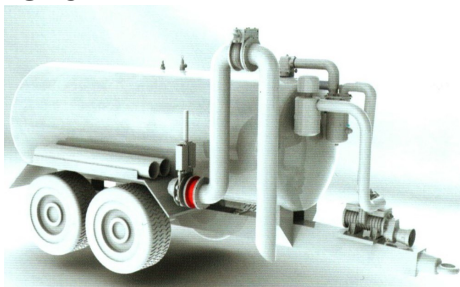

Max. Trykk : 6 bar
360° rotasjon

HYDRAMEK AS





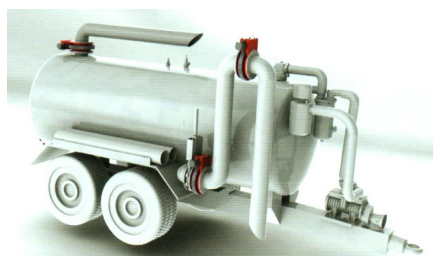

Innv. Diam. Ø mm	Utv. Diam. A mm	Bredde B mm	Boltsirkel D Ø	Antall Boltehull (Ø 15mm)	Varenr.	Pris
100	250	127	220	6	BP5100100001	5.846,-
150	290	127	260	6	BP5100100002	6.037,-
200	350	127	320	6	BP5100100003	6.039,-
250	410	127	370	8	BP5100100004	9.873,-



Svivler—Hydrauliske





Max. Trykk : 6 bar
360° rotasjon
Automatisk brems ved trykkfall
Beskyttelse av utvendige tenner kan leveres på forespørsel.







Innv. Diam. Ø mm	Utv. Diam. A mm	Bredde B mm	Boltsirkel D Ø	Antall Boltehull (Ø 15mm)	Varenr.	Pris
200	350	144	320	6	BP6080200156	*
250	410	144	370	8	BP6080200165	Spør oss

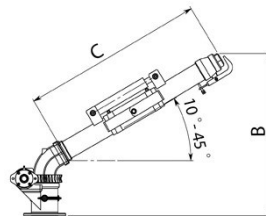

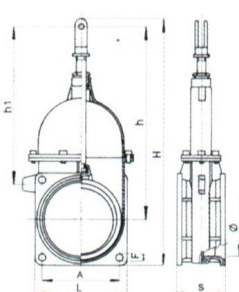

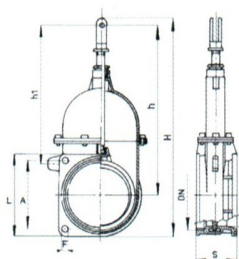

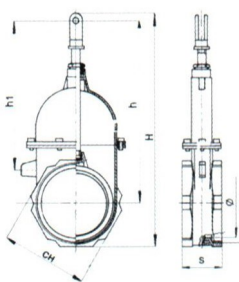
	Beskrivelse	Varenr.	Pris
 <small>HYDRAMEK AS</small>	Sifongventil Ø60 mm. (for MEC4000-5000-6500) <ul style="list-style-type: none"> - Plastkopp for sifong - O-ring for plastkopp/sifong - Gummiball Ø60mm - Bend 90 grader Ø60mm 	RIV360 RIV9891 RIV9896 RIV9912060 RIV9900	2.922,- 895,- 73,- 178,- 944,-
 <small>HYDRAMEK AS</small>	Sifongventil Ø80 mm, plastutførelse, med håndtak (for MEC8000 og større) <ul style="list-style-type: none"> - Plastkopp for sifong - O-ring for plastkopp/sifong - Gummiball Ø80mm - Håndtak for sifong Ø80, plast 	RIV33580 RIV9890 RIV9895 RIV9912080 RIV9889	3.748,- 1.170,- 55,- 240,- 188,-
	Overløpsventil Ø60mm Overløpsventil Ø80mm	RIV41060 RIV41080	3.119,- 3.403,-
	Sifongventil med stor kapasitet 5.000 - 10.000 ltr/min. Ø 80. BPR 10.000 - 18.000 ltr/min. Ø 100. BPS For store pumper, MEC9000 + , WPT.	BP6100200021 BP6100200022	14.143,- 14.759,-
	Overløpsventil med stor kapasitet. 5.000 - 10.000 ltr/min. Ø 80. BPT 10.000 - 18.000 ltr/min. Ø 100. BPU	BP6100200025 BP6100200026	8.904,- 9.416,-
 <small>HYDRAMEK AS</small>	Sikkerhetsventil 1 1/4" (Til MEC 4000) Sikkerhetsventil 1 1/2" (Til MEC 5000 - 8000) Sikkerhetsventil 2" (Til MEC 9000-13500) Sikkerhetsventil 2 1/2" (Til WPT) Sikkerhetsventil 3" Sikkerhetsventil 2" (Til BR)	BP5100200009 BP5100200010 RIV2502 RIV2545212 RIV25453 RIV25452	1.420,- 1.431,- 1.484,- 10.470,- 13.005,- 3.102,-

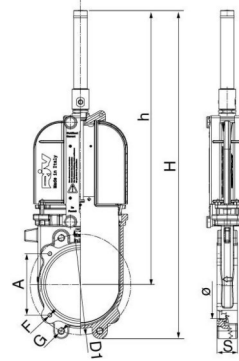
	Beskrivelse	Varenr.	Pris
	Vakumventil, overtrykksventil for vakum i tank. Vakumventil 1 1/2"	RIV290	512,-
	Lyddemper Støyreduksjon ca. 10% Lyddemper, MEC 3000-6500 Lyddemper, MEC 8 000—11 000, Star 60, WPT480 Lyddemper, MEC 13 500, Star 72-84, WPT 600, WPT 720	BP5090000064 BP5090000065 BP5090000066	* * *
	Vakumpumpeolje. Battioni's egen olje forlenger levetiden til de roterende bladene, sikrer best ytelse og riktig smøring. Utmerket motstand mot oksidasjon, anti-rust og anti-skum egenskaper. Arbeidstemperatur mellom - 5 °C til 160 °C Vakumpumpeolje, 5 ltr.	BP5070200100	1.637,-

	Gjødselkanon 4", for hydraulisk drift	BP6100300009	13.246,-
	Gjødselkanon 4", for hydraulisk drift Justerbar tut	BP6100300029	28.020,-
	Hydraulikkmotor for kanon	MEOP080C	3.600,-





	Beskrivelse	Str.	Ø	A	F	H	h	h1	L	S	Varenr.	Pris
	ART 10 - Sluseventil med flens på begge sider 	4"	91	150	13	385	290	235	180	97	RIV10-4	3.311,-
		5"	120	150	13	450	350	295	180	93	RIV10-5	4.238,-
		6"	143	150	13	490	320	320	180	90	RIV10-6	4.232,-
		8"	191	180	13	610	385	385	230	111	RIV10-8	10.041,-
	ART 40 - Sluseventil med flens og gjenger 	4"	91	150	13	385	290	235	180	79	RIV40-4	3.068,-
		5"	120	150	13	450	350	295	180	87	RIV40-5	3.853,-
		6"	143	150	13	490	390	320	180	88	RIV40-6	4.272,-
	ART 60 - Sluseventil med gjenger på begge sider 			CH								
		4"	91	124	-	360	287	235	-	68	RIV60-4	2.437,-
		5"	120	152	-	440	352	295	-	78	RIV60-5	3.675,-
	6"	143	177	-	492	390	320	-	82	RIV60-6	4.185,-	
	ART 124 Knivventil m/ dobb.virk. sylinder 							D1	G			
		4"	100	150	12	686	580	180	16	50	RIV124-4	12.113,-
		5"	125	150	12	766	646	210	16	50	RIV124-5	12.611,-
		6"	150	150	12	840	706	240	20	60	RIV124-6	14.129,-
		8"	200	180	12	994	836	295	20	60	RIV124-8	16.844,-
10"	250	*	*	1243	1046	*	20	70	RIV124-10	32.753,-		

	Beskrivelse	Varenr.	Pris
	ART 163 - Dobbeltvirkende sylinder for sluseventil For 4",5" og 6" ventil	RIV163	2.792,-
	ART 166 - Enkeltvirkende sylinder for sluseventil Med gass For 4" ventil For 5" ventil For 6" ventil For 8" ventil Kort type 6"	RIV166-4 RIV166-5 RIV166-6 RIV166-8 RIV000-6	2.714,- 2.880,- 3.208,- 3.556,- 3.889,-
	ART 151 - Håndtak for sluseventil For 4", 5" og 6" ventil For 8" ventil	RIV151 RIV1518	517,- 824,-
	ART 200 - 3-veis ventil - Blokkeringsfri - Perfekt tilpasning, selv ved vakum. - Smørefri - Grunnet ventilens tetthet er den perfekt både som fordelingsventil og stengeventil. - Tilpasset både manuell og hydraulisk betjening	RIV2016	16.271,-
	Hydraulisk betjening Hydr.sylinder med brakett for Nerone 3-veisventil	RIV173	8.155,-
	ART 4170 - Kuleventil 2 1/2", messing, alu.håndtak, max. 25 bar. 3", messing, alu.håndtak, max 16 bar. 4", messing, alu.håndtak, max 16 bar.	RIV4170212 RIV41703 RIV41704	1.776,- 2.881,- 5.118,-

	Beskrivelse	Varenr.	Pris
	ART 150 Flens for sluseventiler og 3-veisventil For 4" ventil For 5" ventil For 6" ventil For 8" ventil	RIV150-4 RIV150-5 RIV150-6 RIV150-8	296,- 296,- 296,- 721,-
	ART 550 Inspeksjonsglass for tankmontering 2" Inspeksjonsglass inkl. o-ring 3" Inspeksjonsglass inkl. o-ring	RIV5502 RIV5503	45,- 111,-
	ART 552 Festering for inspeksjonsglass Festering for inspeksjonsglass 2" Festering for inspeksjonsglass 3"	RIV5522 RIV5523	115,- 203,-
	Kran for dryppsmørning - enkel - for gjødselpumper Kran dryppsmørning enkel, 6 mm tilslutning AM44/S44/A44/BM44	BP5040200002	389,-
	Kran for dryppsmørning - dobbel - for gjødselpumper Kran dryppsmørning dobbel, 6 mm tilslutning LF12D	BP5040200003	365,-
	Manometer Manometer Ø63, 1/4", -1 / 3 Bar. Manometer Ø63, 1/4", -1 / 3 Bar, Rustfritt hus. Manometer Ø100, 1/2", -1 / 1,5 Bar, Rustfritt hus.	RIV5201460 SI063-01 SI100-02	177,- 399,- 1.040,-

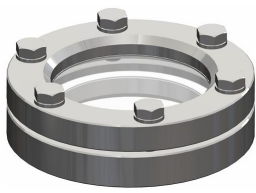
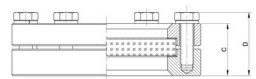
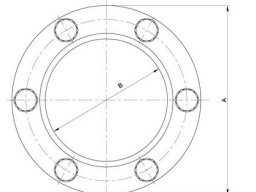
	Beskrivelse	Varenr.	Pris
	3-veis ventil		
	4" ventil med håndtak	MZ002010000L	14.041,-
	5" ventil med håndtak	MZ00212500L	13.653,-
	6" ventil med håndtak	MZ002015000L	19.607,-
	Håndtak for 3-veis ventil		
	Håndtak for 4" ventil	MZ002100015	669,-
	Håndtak for 5" og 6" ventil	MZ002125015	865,-
	3-veis ventil med hydraulisk sylinder		
	4" ventil med hydr.sylinder	MZ0020100600	22.034,-
	5" ventil med hydr.sylinder	MZ002125060	21.098,-
	6" ventil med hydr.sylinder	MZ0020150600	22.585,-
	Hydraulisk sylinder for 3-veis ventil		
	Hydraulisk sylinder for 4" ventil	MZ060100000	7.892,-
	Hydraulisk sylinder for 5" ventil	MZ060125000	7.892,-
	Hydraulisk sylinder for 6" ventil	MZ060150000	7.983,-
	Gummitrakt med klammer		
	Gummitrakt 6" 160/300mm. L=325mm.	IMZH159/6	9.681,-
	Gummitrakt 8" 220/360mm. L=385mm.	MZ0937200000	9.838,-
	Gummitrakt 10"	MZ0937250000	13.693,-
	Nivåmåler		
	Nivåmåler m/flens, lengde 1000mm.	MZ0434100150	5.289,-

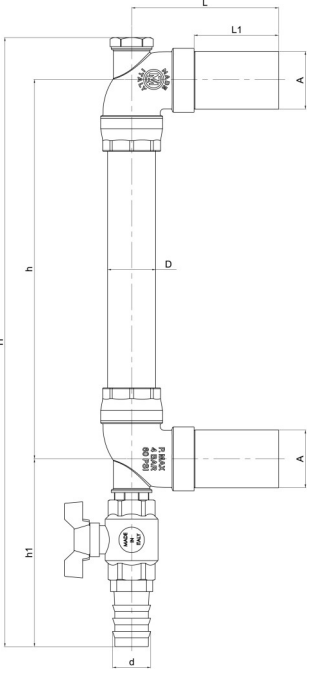
	Beskrivelse	Varenr.	Pris																																								
  	<p>ART 0415/0416 Inspeksjonsglass Ø170/110 mm.</p> <p>AISI304, Herdet glass AISI304, Borosylic glass AISI316, Herdet glass AISI316, Borosylic glass Stål, Herdet glass Stål, Borosylic glass</p> <table border="1"> <thead> <tr> <th>Glass</th> <th>Herdet</th> <th>Borosylic</th> </tr> </thead> <tbody> <tr> <td>P (Bar)</td> <td>2</td> <td>4</td> </tr> <tr> <td>T (°C)</td> <td>-15 +60</td> <td>-15 +260</td> </tr> </tbody> </table> <table border="1"> <thead> <tr> <th>Glass</th> <th>Herdet</th> <th>Borosylic</th> </tr> </thead> <tbody> <tr> <td>A</td> <td>170</td> <td>170</td> </tr> <tr> <td>B</td> <td>110</td> <td>110</td> </tr> <tr> <td>C</td> <td>47</td> <td>57</td> </tr> <tr> <td>D</td> <td>57</td> <td>67</td> </tr> <tr> <td>Vekt</td> <td>4,75</td> <td>5,1</td> </tr> </tbody> </table>	Glass	Herdet	Borosylic	P (Bar)	2	4	T (°C)	-15 +60	-15 +260	Glass	Herdet	Borosylic	A	170	170	B	110	110	C	47	57	D	57	67	Vekt	4,75	5,1	<p>MZ0415100 MZ0416100 MZ0417100 MZ0418100 MZ0419100 MZ0420100</p>	<p>5.516,- 7.572,- 8.334,- 8.480,- 2.923,- 4.982,-</p>													
Glass	Herdet	Borosylic																																									
P (Bar)	2	4																																									
T (°C)	-15 +60	-15 +260																																									
Glass	Herdet	Borosylic																																									
A	170	170																																									
B	110	110																																									
C	47	57																																									
D	57	67																																									
Vekt	4,75	5,1																																									
 	<p>ART 0441 Inspeksjonsglass Ø50 m/tappekran</p> <p>Inspeksjonsglass h=1000 Inspeksjonsglass h=1500 Inspeksjonsglass h=2000</p> <table border="1"> <thead> <tr> <th>mm</th> <th>1000</th> <th>1500</th> <th>2000</th> </tr> </thead> <tbody> <tr> <td>A</td> <td>60,3</td> <td>60,3</td> <td>60,3</td> </tr> <tr> <td>D</td> <td>50</td> <td>50</td> <td>50</td> </tr> <tr> <td>d</td> <td>40</td> <td>40</td> <td>40</td> </tr> <tr> <td>L</td> <td>153,5</td> <td>153,5</td> <td>153,5</td> </tr> <tr> <td>L1</td> <td>88,5</td> <td>88,5</td> <td>88,5</td> </tr> <tr> <td>H</td> <td>1240</td> <td>1740</td> <td>2240</td> </tr> <tr> <td>h</td> <td>1000</td> <td>1500</td> <td>2000</td> </tr> <tr> <td>h1</td> <td>195</td> <td>195</td> <td>195</td> </tr> <tr> <td>Vekt</td> <td>4,42</td> <td>4,575</td> <td>5</td> </tr> </tbody> </table>	mm	1000	1500	2000	A	60,3	60,3	60,3	D	50	50	50	d	40	40	40	L	153,5	153,5	153,5	L1	88,5	88,5	88,5	H	1240	1740	2240	h	1000	1500	2000	h1	195	195	195	Vekt	4,42	4,575	5	<p>MZ0441100 MZ0441150 MZ0441200</p>	<p>3.324,- 3.871,- 3.900,-</p>
mm	1000	1500	2000																																								
A	60,3	60,3	60,3																																								
D	50	50	50																																								
d	40	40	40																																								
L	153,5	153,5	153,5																																								
L1	88,5	88,5	88,5																																								
H	1240	1740	2240																																								
h	1000	1500	2000																																								
h1	195	195	195																																								
Vekt	4,42	4,575	5																																								